

InLab[®] Expert Go-5m-ISM

pH Ref °C ISM

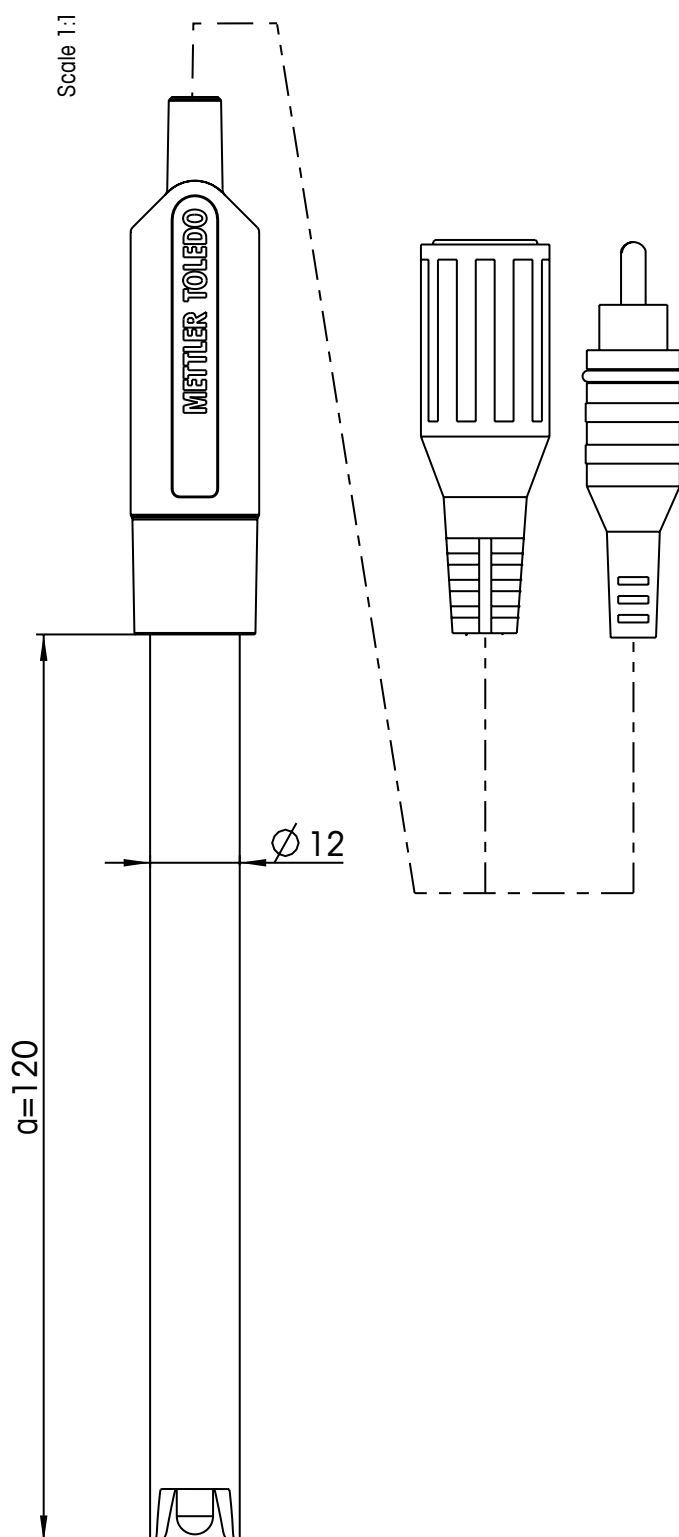

For portable applications in the lab and outdoor;
robust and maintenance-free



Sensor type combined pH electrode

Order number 51344103

Specifications

pH range 0...14

zero point (pH) 7.00 ± 0.25

temperature range 0...100 °C

temperature probe NTC 30 kΩ

shaft material PEEK

membrane glass U

membrane resistance < 250 MΩ

reference system ARGENTHAL™

reference diaphragm double open junction

reference electrolyte XEROLYT[®] polymer

bridge electrolyte -

electrode head -

cable length 5 m

connector BNC / RCA (Cinch) IP67

cell constant (cm⁻¹) -

cell type -

indicating metal -

Storage

InLab storage solution (30111142)

or FRISCOLYT-B[®] (51340053)